

BASIC MANUAL

FREEDOM^{HD}



DOF

 **Table of Contents**

Note	3
Check the Contents	4
Scanner Parts	5
Plates	6
Connect the Scanner	7
System Requirement	7
Software Installation	8
After Installation	9 - 10
Select Language	11
Calibration	12
Mouse Motion	13
Icons	14 - 19
Basic Scan Sequence	20 - 31
Our Office Locations	32

Note (Remarque lors d'une installation)

- Avoid setting up the scanner in an environment where there is a direct exposure to a sunlight. The strong light can interfere with the projection light from the scanner and in turn can affect the scan performance.
(Lors d'une installation du produit, évitez le rayon direct. Si le projecteur est exposé sur le rayon direct, la qualité de produit du data de balayage baisse.)
- Once you turn on the scanner, the scanner needs about 10 seconds to boot up. Please run the ScanApp SW after the scanner finishes booting.
(Après l'alimentation électrique au produit, on a besoin d'un temps de préchauffage du scanner environ 10 secondes. Le programme de balayage fonctionne après avoir fini le préchauffage.)
- Do not use USB WiFi adapters along with the Freedom HD scanner. In order to obtain the maximum performance, Freedom HD uses the full USB bandwidth. Using USB WiFi adapters may result in scan failures.
(Il ne faut pas utiliser à la fois le scanner et l'équipement d'USB sans fil afin d'obtenir le meilleur data de balayage. Lorsqu'on utilise le scanner et l'équipement d'USB sans fil ainsi que la carte de LAN sans fil d'USB etc, il peut se produire une erreur du balayage.)
- It is good practice to perform Scanner Calibration everyday but it is not mandatory. Do calibrate the scanner at least once a week or right after the scanner had been moved to another place.
(On recommande d'exécuter une seule fois par an le travail en coopération. Aussi, au moment d'avoir déplacé le scanner, on doit exécuter le travail en coopération.)

Safety Precautions (Remarque pour sécurité)

- Hazardous Direct Light – Keep eyes away from the direct light while in operation.
(Interdit de regarder directement le rayon du projecteur émis pendant le fonctionnement du balayage.
Le rayon émis du projecteur pourrait nuire aux yeux.)

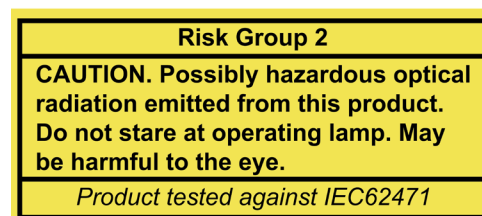

▶ Check the Contents

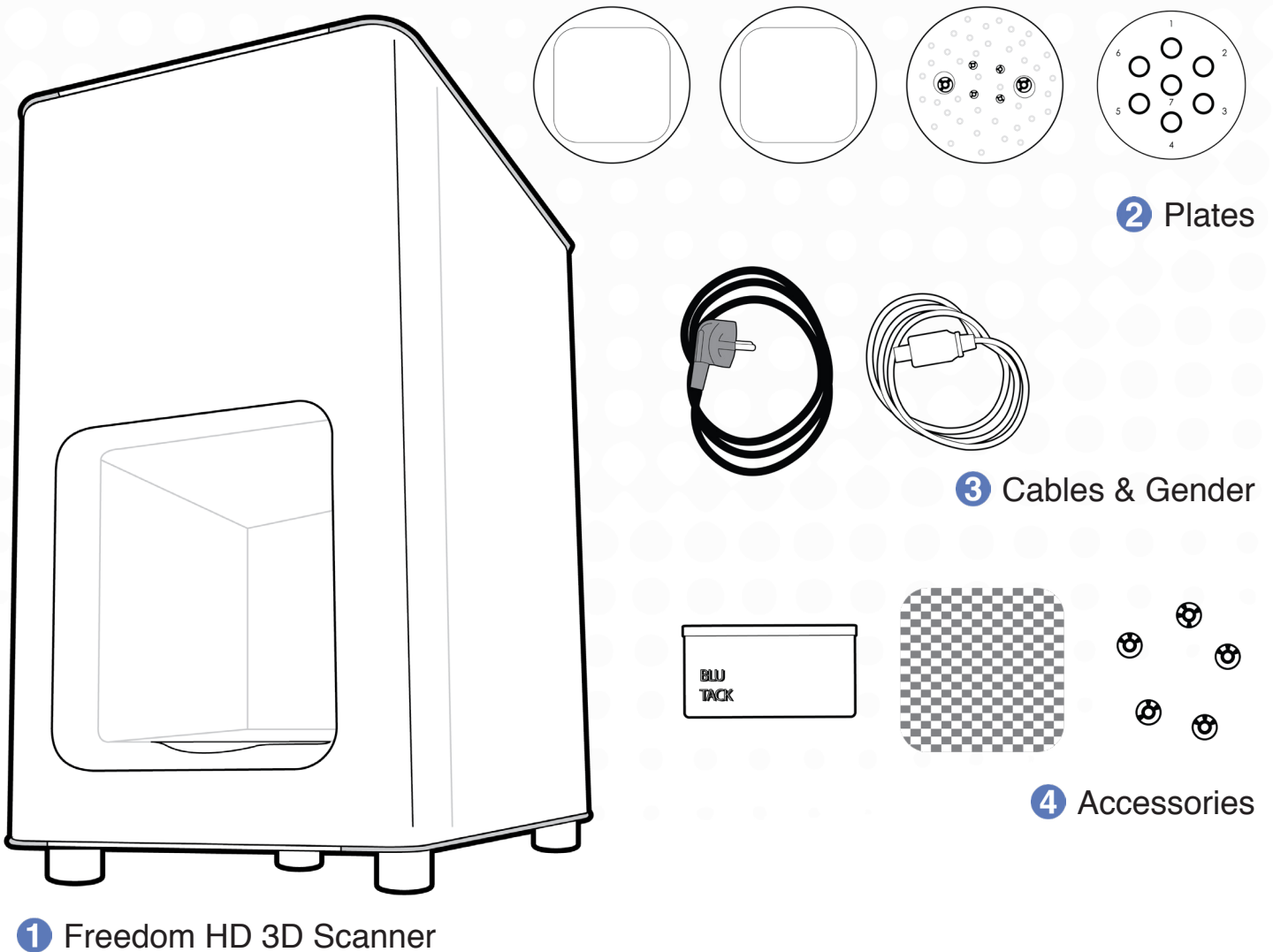

- 1** Freedom HD 3D Scanner
- 2** Plates – Scan Plates (2qty), Calibration Plate (1qty), Multi-Die Plate (1qty)
- 3** Cables & Gender – Power Cable (1qty), USB Cable (1qty)
- 4** Accessories – Blue Tack (1qty), Mesh Mat (1qty), Scan Targets (5 pieces)

* **Optional Plates** – Transfer Plate A, Transfer Plate S, Transfer Plate B, All-in-One Plate, Transfer Plate and Hybrid Target for Tactile Scanner

Scanner Parts

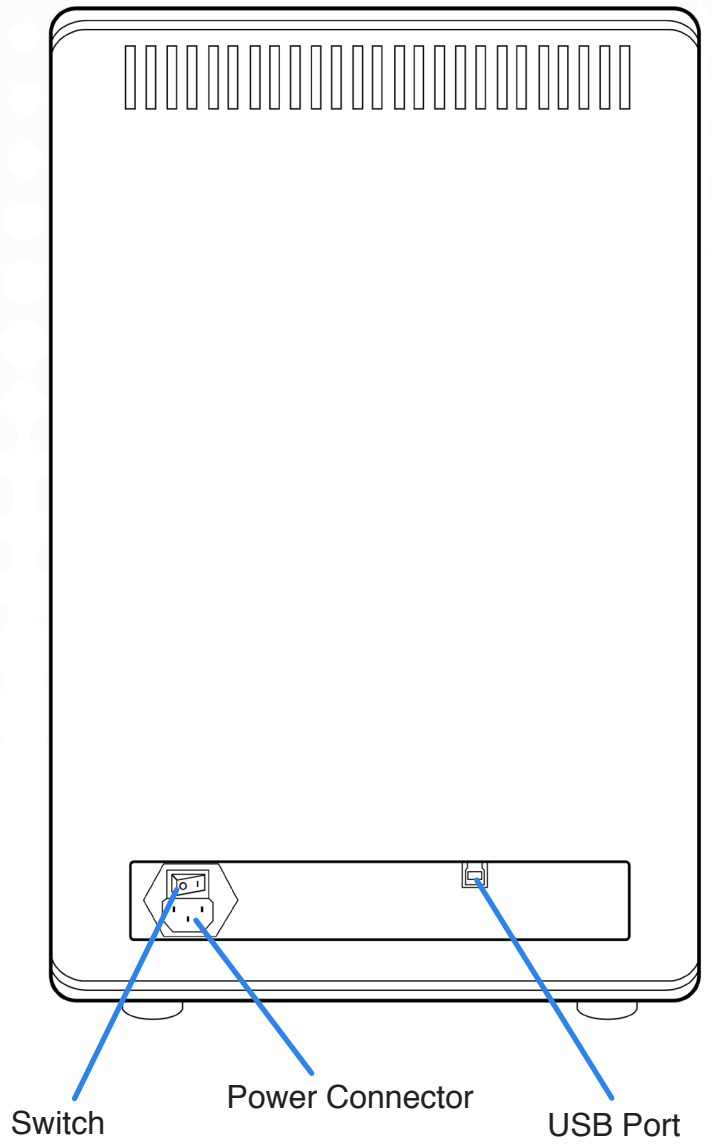
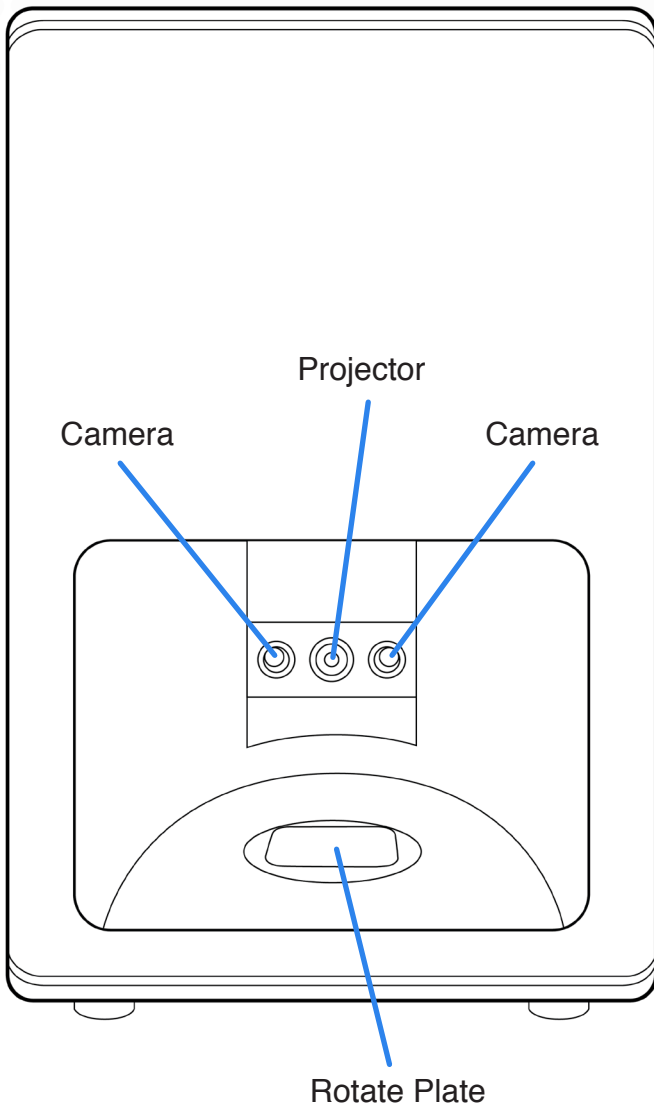

Plates

Basic Plates

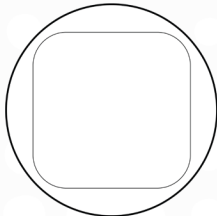

Scan Plate

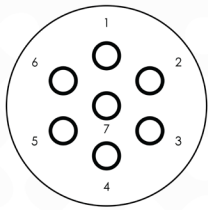

Multi-Die Plate

Calibration Plate

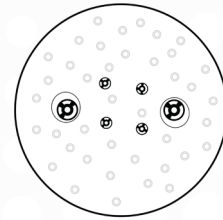

Optional Plates

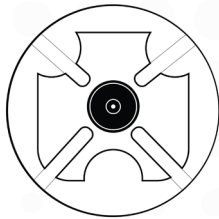

Transfer Plate A
for Artex

Transfer Plate S
for KaVo and SAM

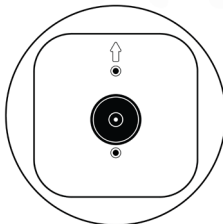
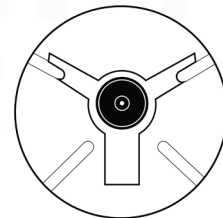

Transfer Plate B
for Bio-Art

Implant-Die Plate

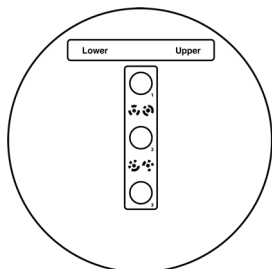
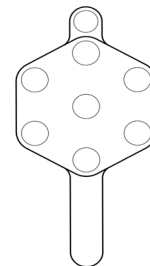

All-in-One Plate

Transfer Plate
for Tactile Scanner

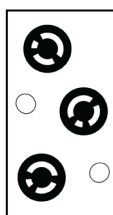
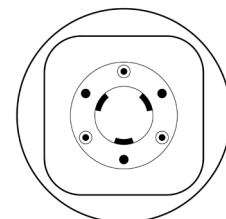

Hybrid Target
for Tactile Scanner

▶ Connect the Scanner

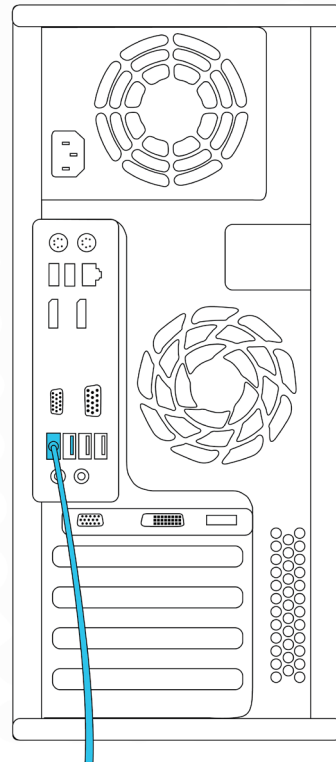
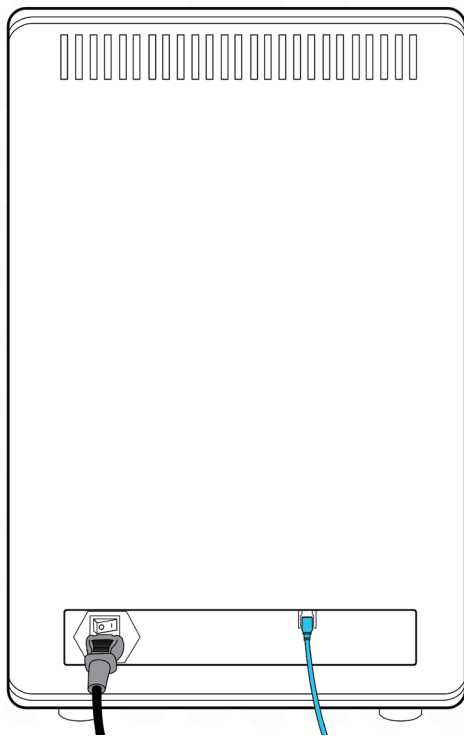

- 1 Make sure your scanner power is off. Connect your power cable.
- 2 Connect the USB cable to one of your USB 3.0 ports at the **back of your PC**.
- 3 Do not use USB WiFi adapters.

▶ System Requirement

- Operating System - Windows 7, 8, 10 (64-Bit)
- RAM - 16GB
- Graphic Card - Recommend higher than 2GB (NVIDIA GeForce GT750Ti)
- HDD / SSD – 500GB or Higher / 128GB or Higher
- CPU - Intel 4th generation CPU i5 / i7-4790, Intel 6th generation CPU i5/ i7-6700
 - ⚠ Do not use AMD CPU. (Ne pas utiliser AMD CPU.)
- Chipset – Z97, H97, X99, Q170, Z(H)170, H110
 - ⚠ Do not use ASRock mainboard. (Ne pas utiliser la carte mère de ASRock.)
- USB Ports - USB 3.0

* Assembled PC and DOF scanner might not be compatible and note that DOF Inc. have no responsibility for any problem caused by unknown pc. You are highly recommended using HP800G2 desk top PC provided by DOF. (En cas de PC monté, il peut se produire un problème au niveau de la compatibilité et DOF ne prend pas tel problème en charge. On recommande d'utiliser HP 800 G2 Desktop PC offert par le siège social de DOF.)

Software Installation

- 1 Run the ScanApp SW locating at DOF USB from the accessory box or download the latest ScanApp SW from the link you have obtained from your dealer/reseller.
 - 2 Install the software.
 - 3 Follow the wizard to successfully install the ScanApp SW.
- * Restarting the PC after installation is recommended.
* Updating Window OS is recommended before installation.

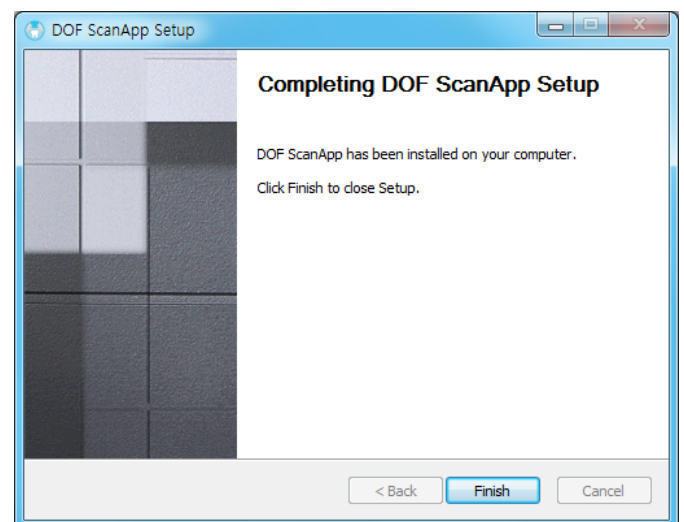
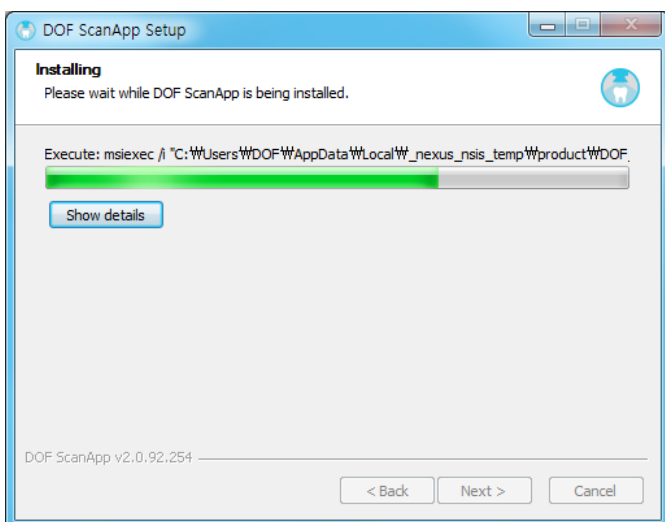
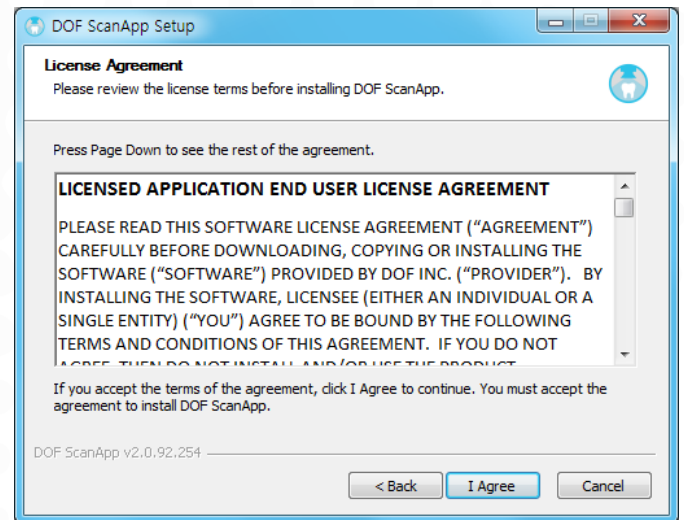
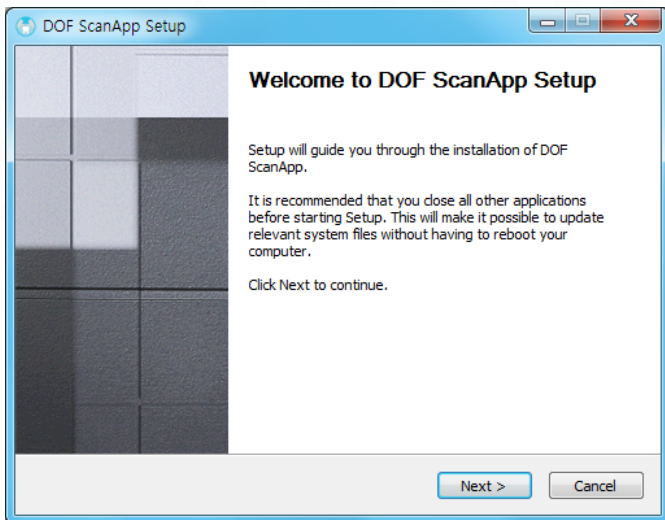

▶ After Installation

Once you have both applications installed on your PC, you need to make a connection (integration) between ScanApp and exocad.

ScanApp and exocad are two separate applications. ScanApp is responsible to control and perform scan operations while exocad is responsible to design the digital restorations.

- 1 Check if both of the software is installed properly.
- 2 Run the ScanApp for the first time.
- 3 Press exocad icon.



Opens DOF Start.



Helps to choose desired dental CAD platform.

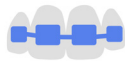

Directs straight to Orthodontic Scan.



Prompts dental DB selection.



Project Backup File Manager - helps to retrieve scanned data.

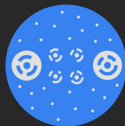

Calibrates.



Teamviewer shortcut.

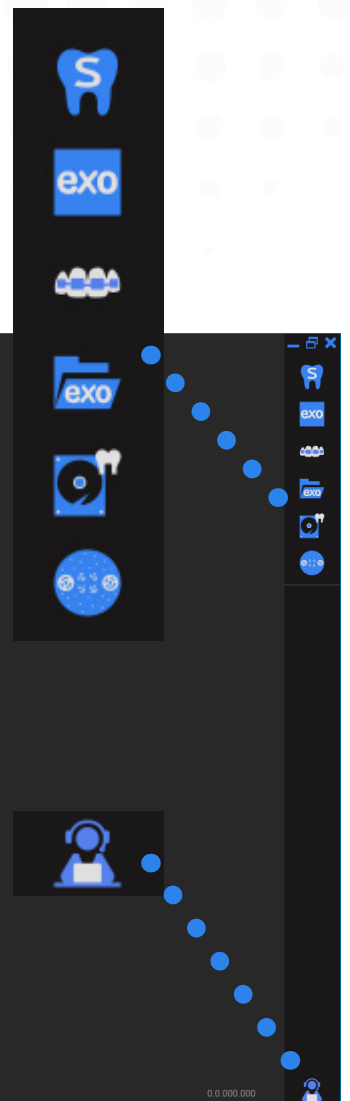

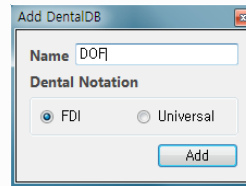
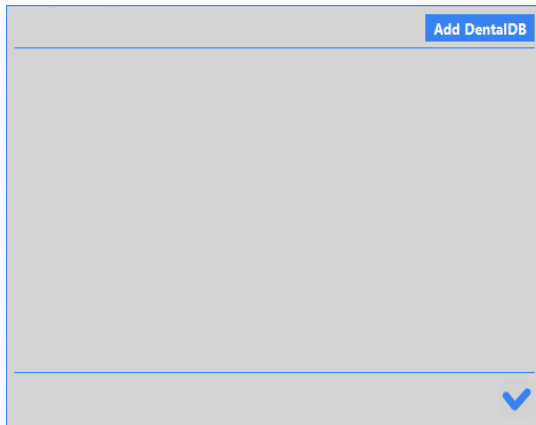

- 4 You can choose notation system.
(Notation or Universal)

- 5 You will be asked to specify the exocad DentalDB.exe is located. DentalDB.exe is usually located under the exocad-DentalCAD-versionnumber/DentalDB/bin/ folder.

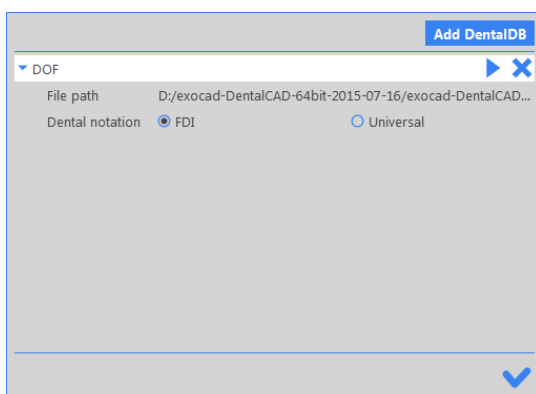
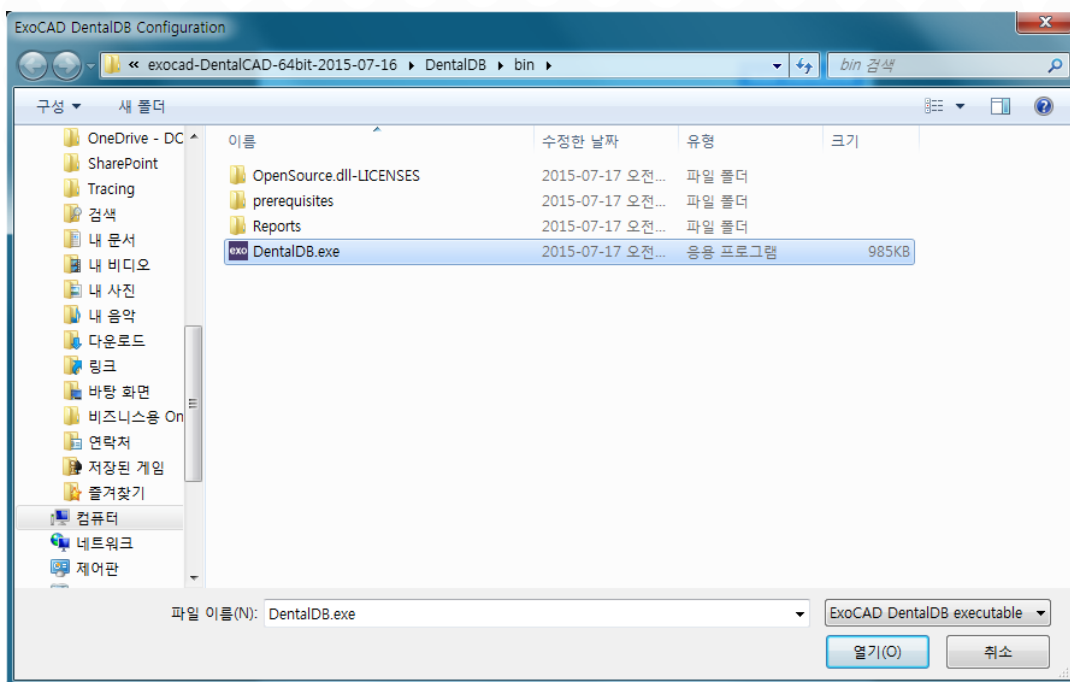

- 6 After DentalDB is added, press run.

Select Language

- 1 Run the ScanApp.
- 2 ScanApp icon will be appeared at the hidden icon taskbar.
- 3 Right click the ScanApp icon and click “Information” option to change the language of the program.

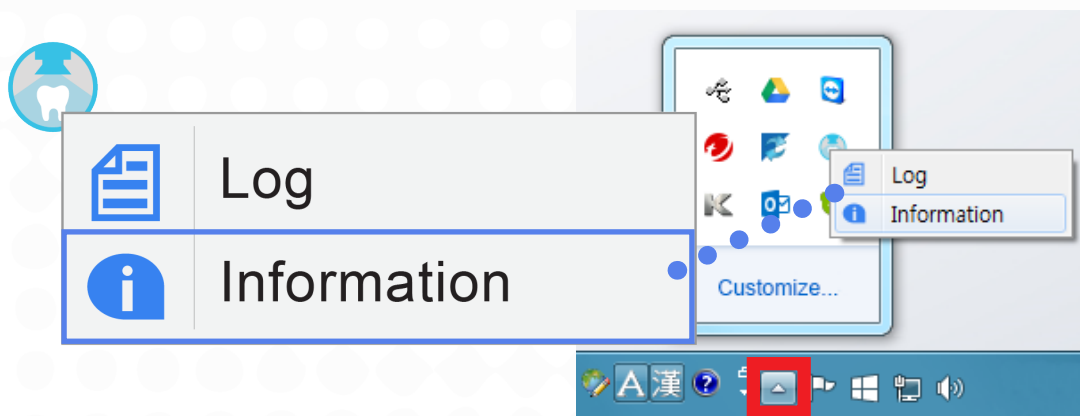

- 4 Select your language.

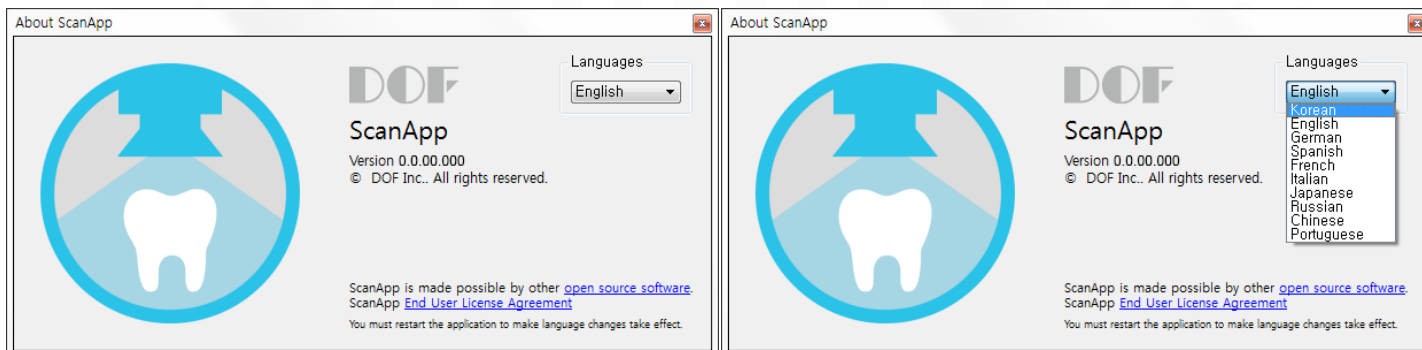

Available languages: Korean, English, German, Spanish, French, Italian, Japanese, Russian, Chinese, Portuguese

► Calibration

- 1 Make sure your scanner is connected and power is on.
- 2 From the ScanApp application, click 
- 3 Press Start after placing calibration plate.
- 4 Place the two “Scan Plates” on the scanning platform and then place the “Calibration Plate” on top of it.

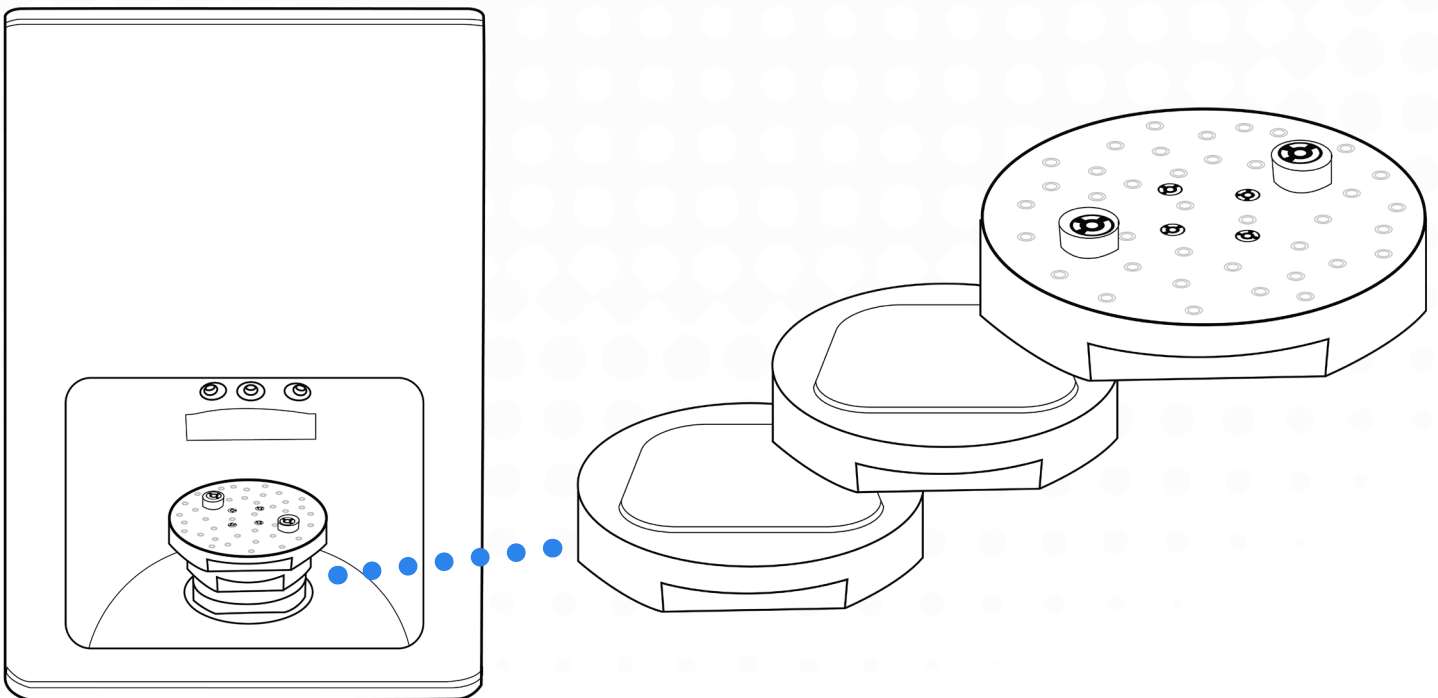

- 5 It will take from 5 minutes to 10 minutes depending on the computer performance.

* Calibrating a scanner once a month or after its movement is recommended.

 **Mouse Motion**

Mouse Button	Motion	Explanation
Left	Click	Select
	Hold and Drag	Select scan areas
Right	Hold and Drag	Rotate the view
Right & Left	Hold and Drag	Move the view
Scroll Wheel	Scroll Up	Zoom in
	Scroll Down	Zoom out
	Hold and Drag	Move the view

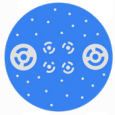
 **Icons****1** Pre Setting

Calibrate



Save – Enables one to start scanning from where it ended.



Current Project – Indicates what types of restoration will be fabricated.



Reload - Reloads the updated data of the Job Definition at exocad



Manual Mode – Allows to freely jump to desired scanning step



Open Project Folder - Loads dental project



Plan – Allows scanning types to be altered (impression, stones, etc.)

2 Scan Icon

Articulator



Prep-Die



Multi-Die



Upper Base



Lower Base



All-in-One



Gingiva



Scan Abutment



Face Bow



Upper Interproximal



Lower Interproximal



Upper Situ



Inner Situ



Upper Impression



Lower Impression



Quadrant Arch Upper



Quadrant Arch Lower

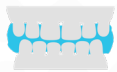

Bite Registration



Tactile Scanning*



Tactile Scanner Calibration*

*Tactile Scanning and Tactile Scanner Calibration functions are available with combination of Freedom HD and Renishaw Incise[†] scanners.

[†]Renishaw and Incise are trademarks of respective companies.

3 Camera

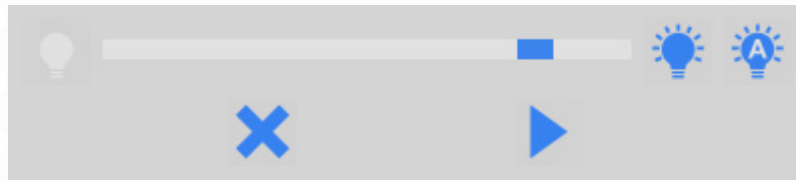

Dark - Incremental adjustment of brightness.

Bright – Incremental adjustment of brightness.

Auto Exposure

Cancel

Scan

4 Scan

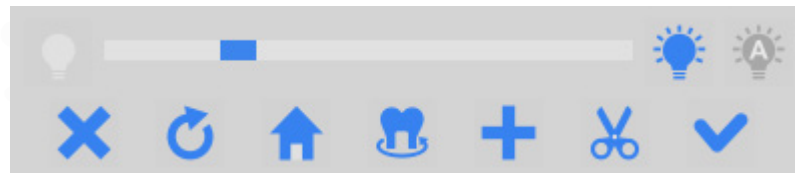

Rescan - Automatically deletes current scanned data for another attempt.

Home - Repositions rotating arm/stage to default degree.

Preview - Allows users to check how much models will be exposed to camera exposure.

Scan Additional

Edit - Trims undesired data.

5 Match

Previous Model



Auto Align - Automatically allocates 3 dots among scanned data.



Match - Helps to join manually allocated data.



Next Model

6 Post Setting

Match – Combines scanned data.



Build – Prepares rendering process for designing.



Trim – Removes unnecessary data for optimum data process.



V.A Alignment (Virtual Articulator Alignment) - Transfers position of fully articulated models to CAD.



Hole Filling - Fills up misscanned area.



Save – Saves STL file.



CADapp – Directly takes to designing platform (saves data automatically).

7 View

Front View – Upper model base.



Rear View – Lower model base.



Left View – Left buccal side.



Right View – Right buccal side.



Top View – Facial side.



Bottom View – Lingual side.



Fit to Window



Wireframe



Texture On / Off

Basic Scan Sequence

- 1 Open Dental DB.
- 1 Define and select Customer, Job, and Technician.

Project

Select next action from the tool bar on the right.

Date: 2016-01-20 오전 10:36:37 Case ID: 00002-001

Client: 00002 DENTAL CLINIC

Name: CHOLMINWOOK

Technician: 002 CHOLMARCUS

Notes:

Project status: 2016-01-20_00002-0...

Scanning CAD Upload NC Open in explorer

Job definition

Multitide mode

Legend:

- Anatomic crown
- Adjacent tooth
- Antagonist

Tooth shades: A1

Scan mode: Two stone models, in occlusion

Actions

- Scan with ScanApp
- Scan
- Design
- Manufacture
- Model Creator
- dentalshare
- Copy

exocad 5675

- 2 Define your dental indications from the tooth diagram on the right.

Tooth 46 Material configuration (local): Default

Crowns/Copings

- Anatomic crown
- Coping
- Pressed crown
- Offset coping
- Provisional crown
- Preform crown

Pontics

- Anatomic pontic
- Reduced pontic
- Pressed pontic
- Provisional pontic

Inlays, onlays and veneers

- Inlay/Onlay
- Offset inlay
- Veneer

Digital copy milling

- Anatomic waxup
- Reduced waxup
- Pontic waxup

Primary units

- Bar pillar
- Bar segment
- Attachment
- Telescopic crown

Bite splint

- Bite splint
- Bite splint (missing tooth)

Residual Dentition

- Antagonist
- Adjacent tooth
- Missing tooth

Material

5-Axis / Laser / 3D Print

- Composite
- NP Metal
- NP Metal (Laser)
- PMMA
- Zirconia

Options & Parameters

Implant based? No implant

Scan a pre-op model? No

Scan gingiva separately? No

Minimal thickness: 0.6 mm

Gap thickness of cement: 0.08 mm

Color: ---

Clear OK

- 3 Define Scan Model type.
- 4 Click "Save" button and you will see "Scan with ScanApp" button being active.

2 Click the “ScanApp” button to run the scanning application.



Scan with ScanApp



1 Your “Scan Wizard” will guide you through the scanning process. The first wizard step lets you choose different scanning options.

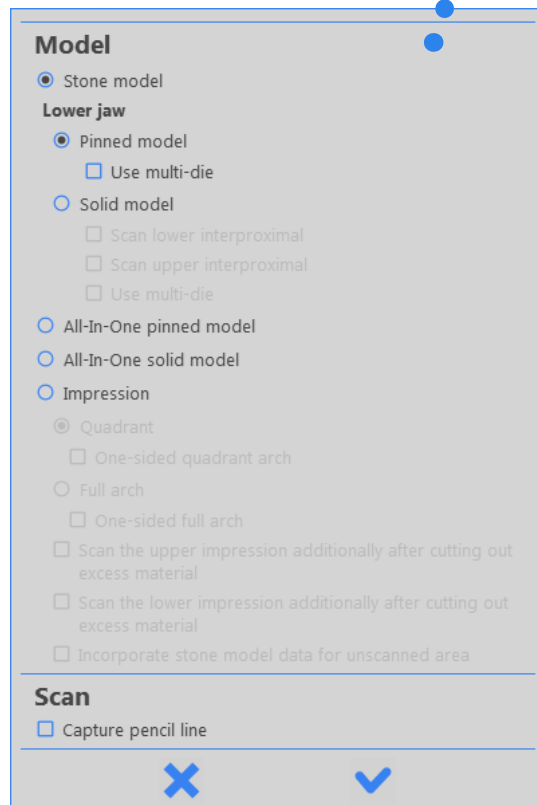

3 Place a model on the scan platform.

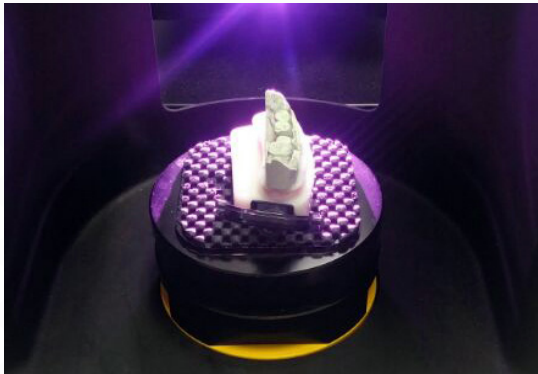

- 1 Place a mesh mat to prevent slipping of the model. The model should be placed as the incisor is faced towards the inside of the scanner.

- 2 From the “Camera View” windows, check if the model is in the camera view. You can adjust the height of the model by removing or adding “Scan Plates” from the scan platform.
- 3 Adjust the “Brightness Level” from the “Camera View”. The red color indication means that the scanner camera exposure is too high. In this case, reduce the “Brightness Level” so that the red indication be disappeared. This procedure should be done whenever scan object of interest changes. If you want to use manual exposure, turn on the “Auto exposure”  check box.

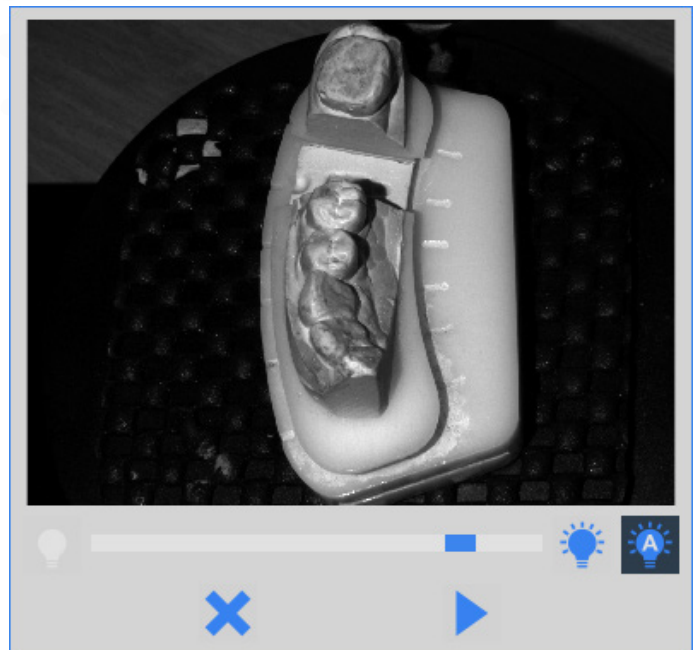
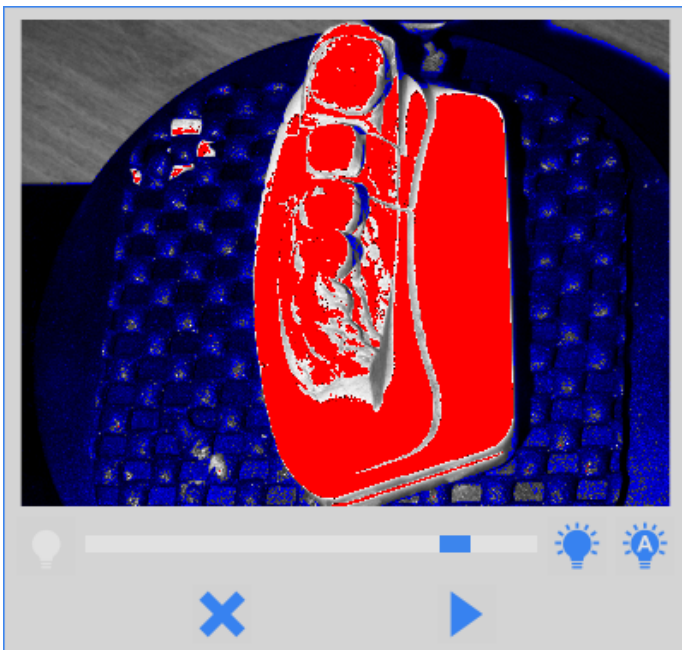

4 Pre-scanning

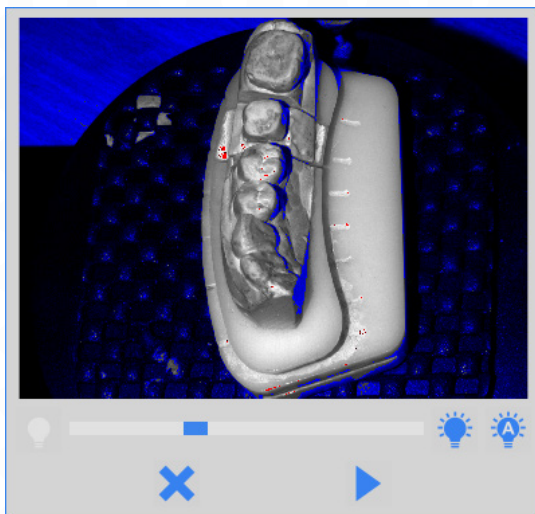

- 1 Place an adjacent model in the platform and click "Scan" ▶

- 2 The scanner will obtain the overall shape of your adjacent model.

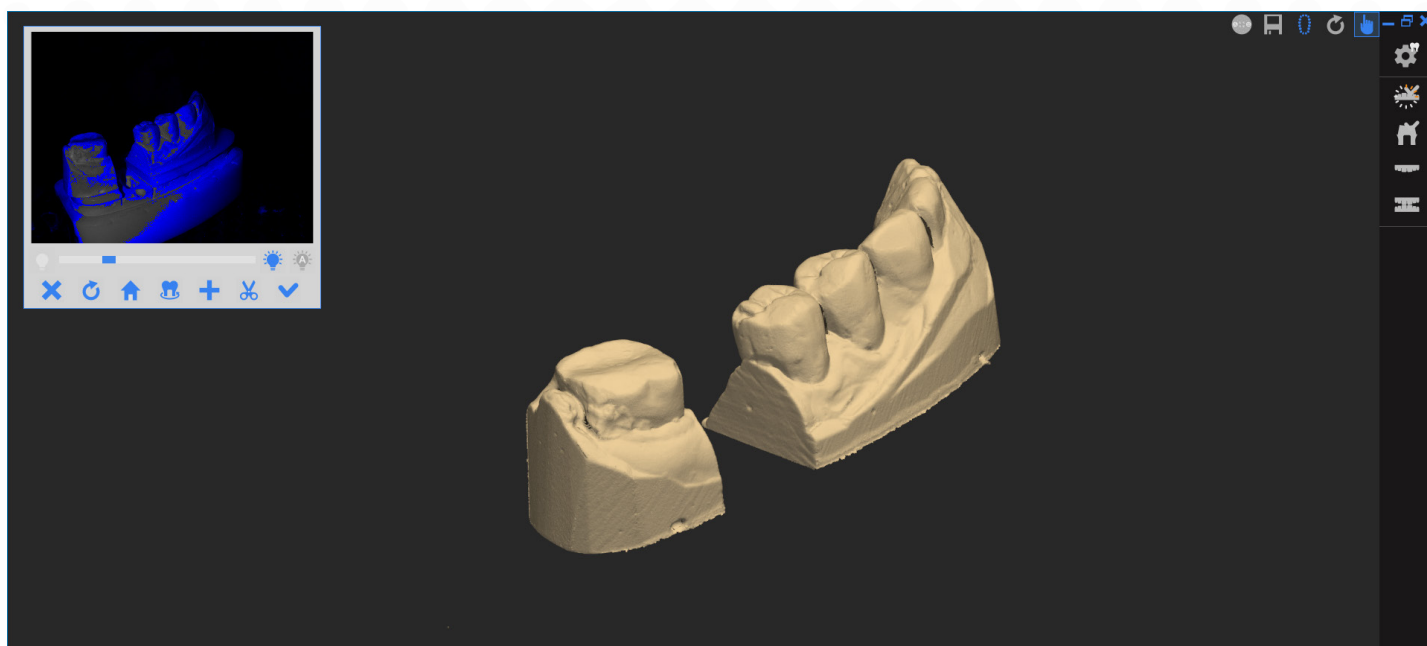

A first quick scanning will be performed and this will capture the overall shape of your model. A detailed scanning of your prepped dies will be done during later steps, so you do not need to capture everything at this stage.

The main purpose of pre-scan data is to help other data (such as detail scan data, implant scan data, wax-up data) to be aligned correctly in relation to your actual model.

5 Supplemental Scanning

After each batch of scanning, there are two ways to fill in more data to your scan. Rotate and position the 3D data so that you are able to see the missing area.

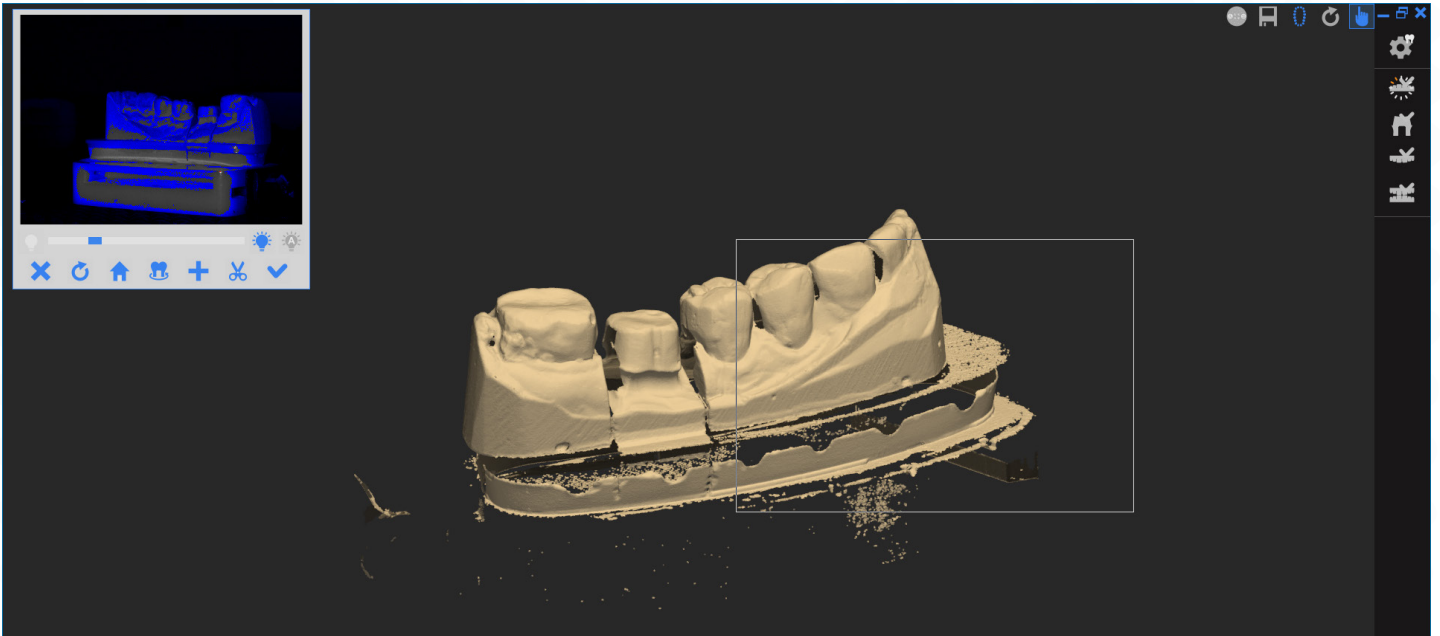

- 1 - Drag desired additional scan area and release the mouse button for scanning.
 - Click "Scan Additional" **+** to scan the view you are looking at.
 - Press "S" of the keyboard to scan the view you are looking at as well.

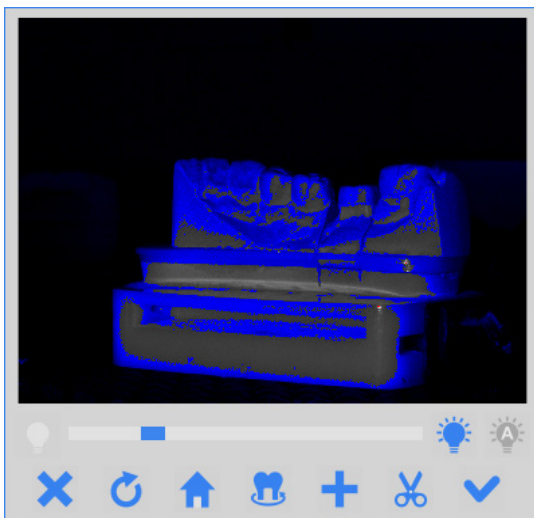

- 2 Delete unnecessary scan data by clicking "Edit" **✂**
- 3 Click "Okay" **✓** after finishing the scan.

6 Prep Teeth Scanning (Detail Scanning)

In the Prep Teeth Scanning step, you will be asked to take out all adjacent teeth from the model, only leaving the prepped dies on the model. Set the brightness level so that you have the optimal brightness level for the prepped dies.

Depending on the indication complexity, you will need to repeat the “Prep Teeth Scanning” twice.

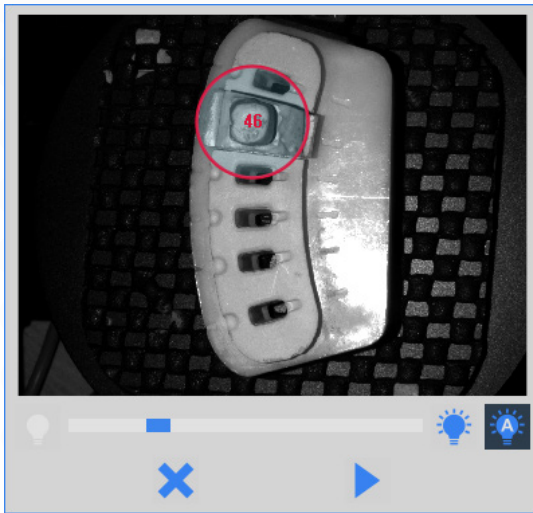

1 The scanning area can be defined by left mouse clicks. You can adjust the size of circles with the scroll wheel and move circles via clicking-and-holding the left mouse button.

2 Click  to perform scanning.

3 After this step, you will have another chance to do “Supplemental Scanning”. Check your prepped teeth data and confirm if everything is okay. If not, fill in incomplete areas.



7 Antagonist Scan

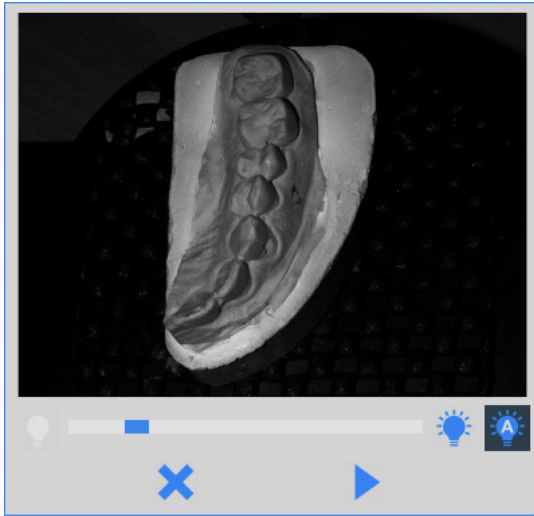

- 1 Place an antagonist model in the platform and click “Scan”

- 2 The scanner will obtain the overall shape of your antagonist model.

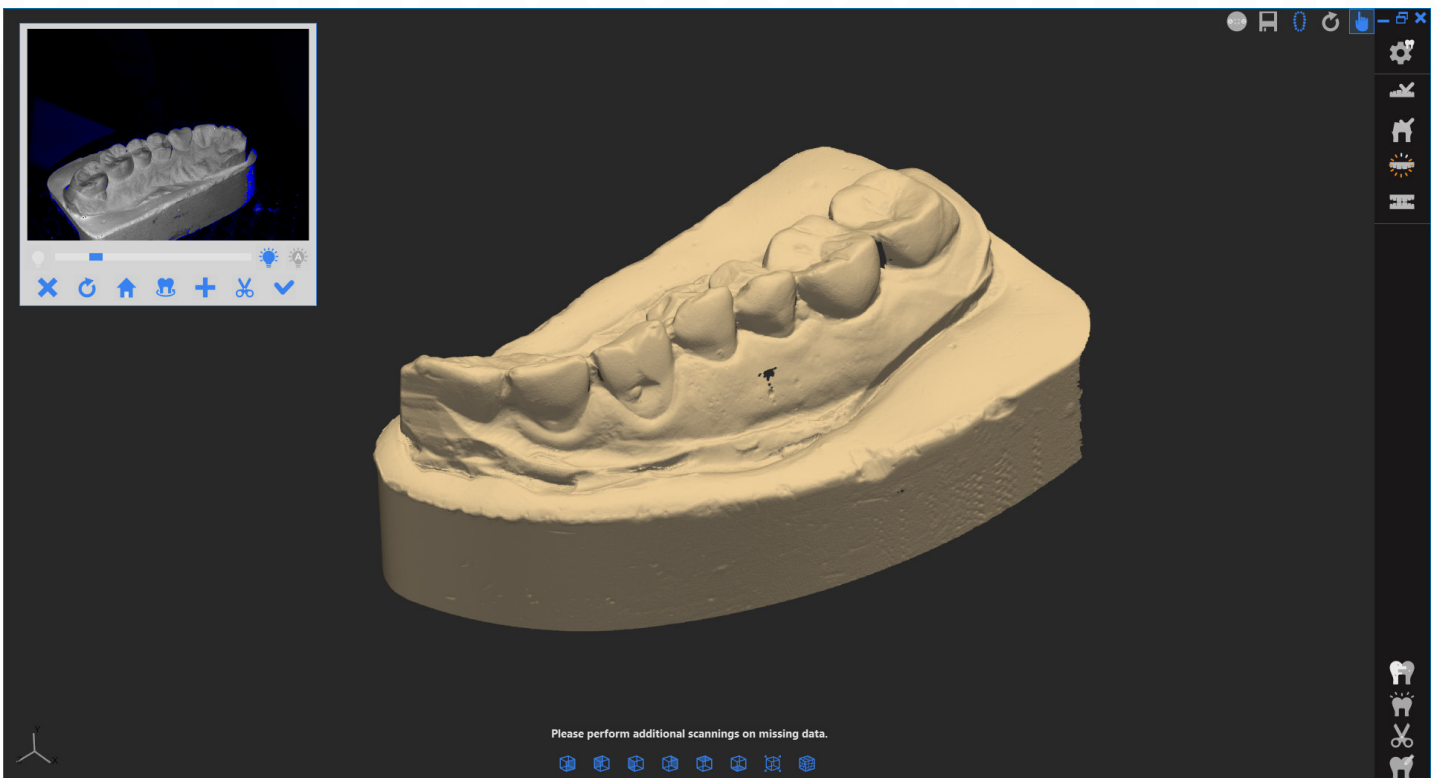

You will have another chance to do “Supplemental Scan” if you need to fill in incomplete areas.

8 Occlusion Scan

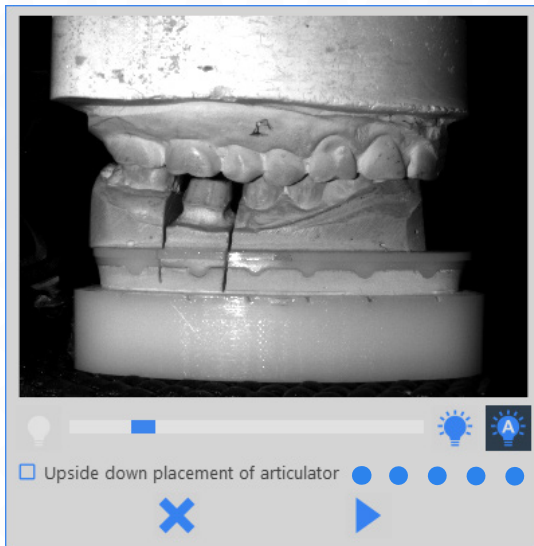

- 1 Place an occlusion relationship model in the platform and click "Scan" ▶

Upper jaw is usually placed on top, but if the lower jaw is placed on top, check the box.

- 2 The scanner will obtain the overall shape of your occlusion relationship model.

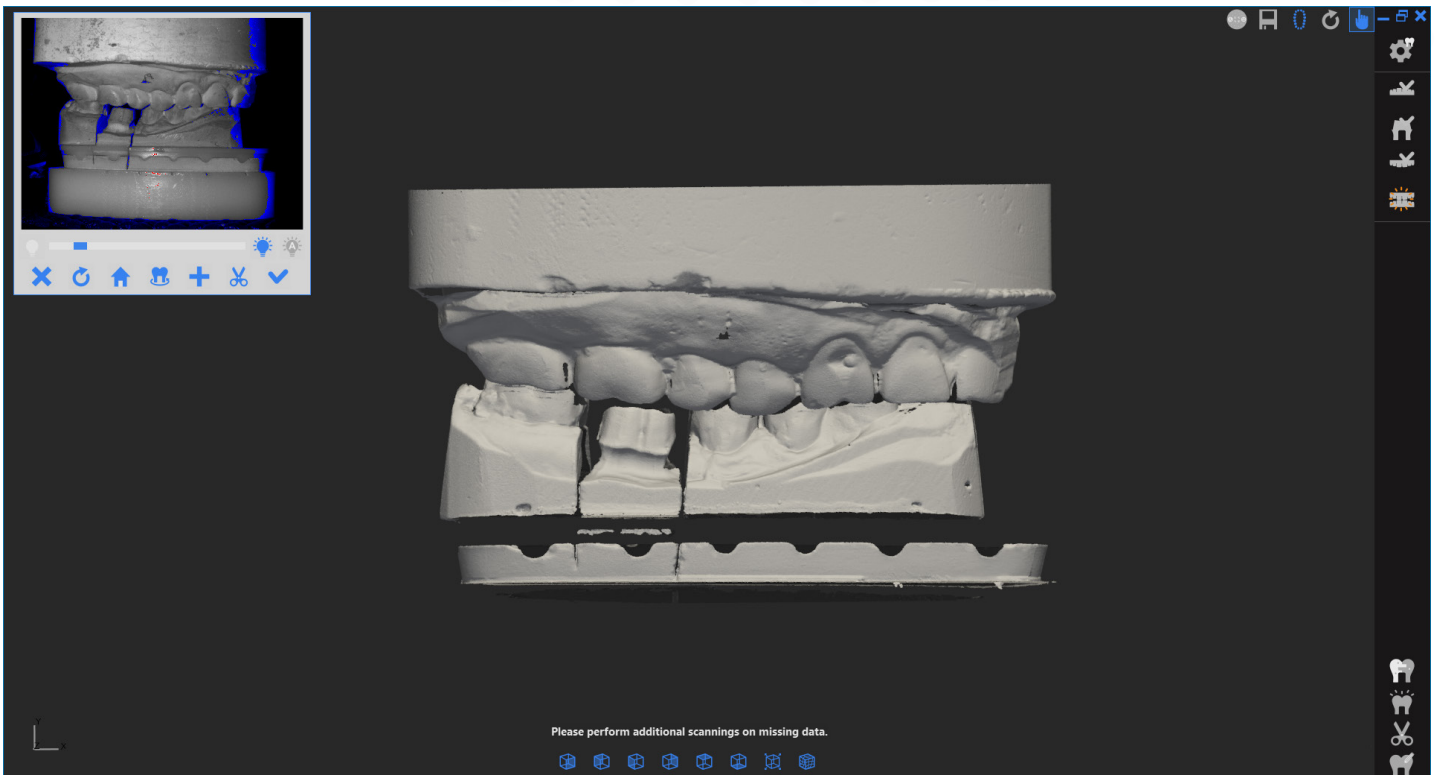

- 3 You have two options to scan occlusion relationship.



- A** By stone model/simple articulators:
Simply place the articulated upper and lower jaws on the scan platform. The camera axis will move up and down to capture your occlusion relationship.



- B** By fully adjusting articulators:
Remove all "Scan Plates" from the platform and insert fully adjustable articulator in the platform. You will get the best result if the incisor pin is removed from the pin.

9 Alignment (Matching) of Scan Data.



- 1** This step is to match the "Pre-Scan" and "Detail Scan" data you have obtained from the previous step.



- 2** This step is to match Upper/Lower jaws to scanned occlusion data.

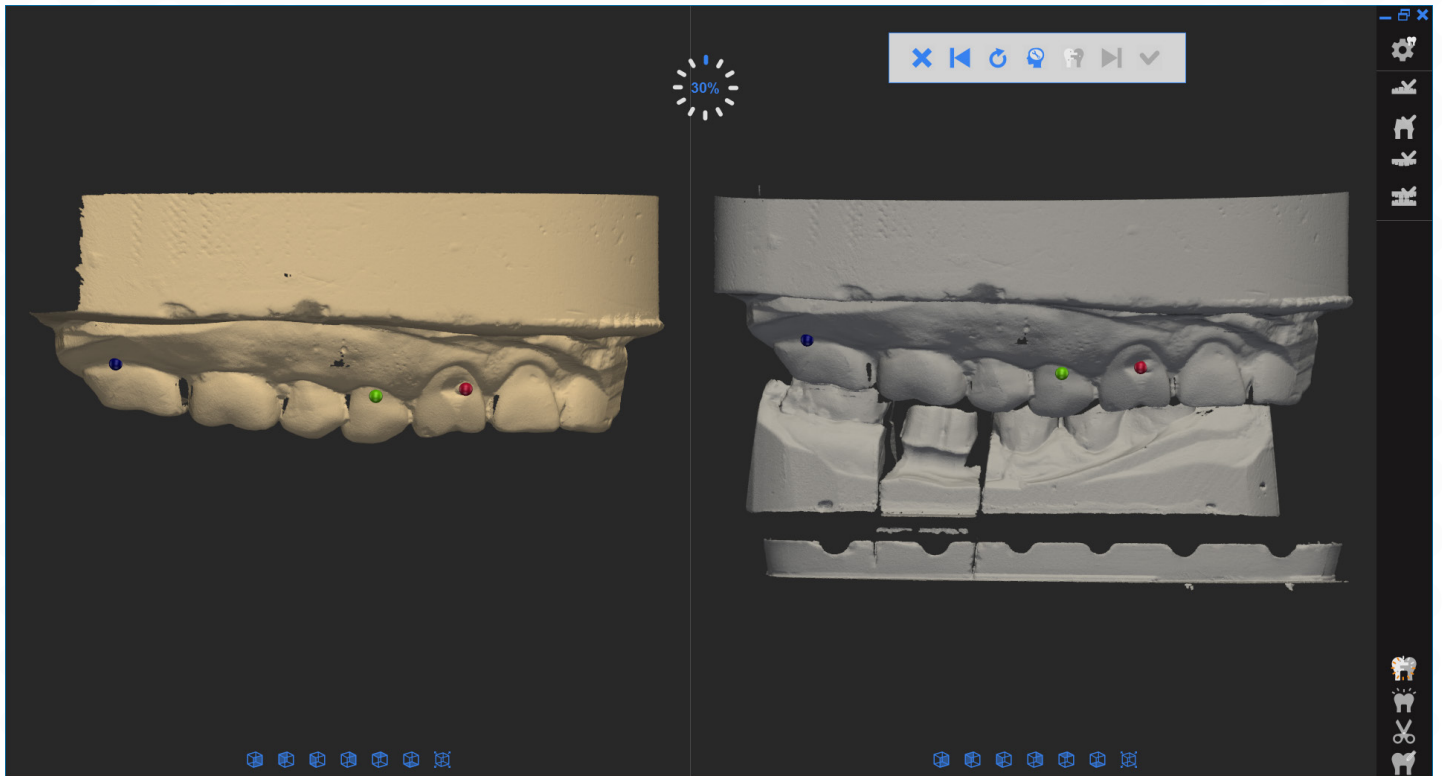

- Auto Alignment 

If the two sets of scan data are in similar directions and have relatively unique shape, then most likely your data will be matched automatically. This can be checked from the right section of “Alignment Window”. If the two different colored data are combined in the right positions, then the alignment had been successful.

- Alignment Fail:

If the two sets of scan data are mismatched as you see from the diagram, it means alignment is not successful. Click “Restart”  button to reset the positions of the data and do “Manual Alignment”.

- Manual Alignment:

You can manually align the two sets of data by using 3-point matching technique. Choose one, two or three common points on the data that from the left and right sections of “Alignment Window”. You must select points that exists in both data. Click “Align”  button on the bottom after you select one or two points.

10 Data edit and confirmation.

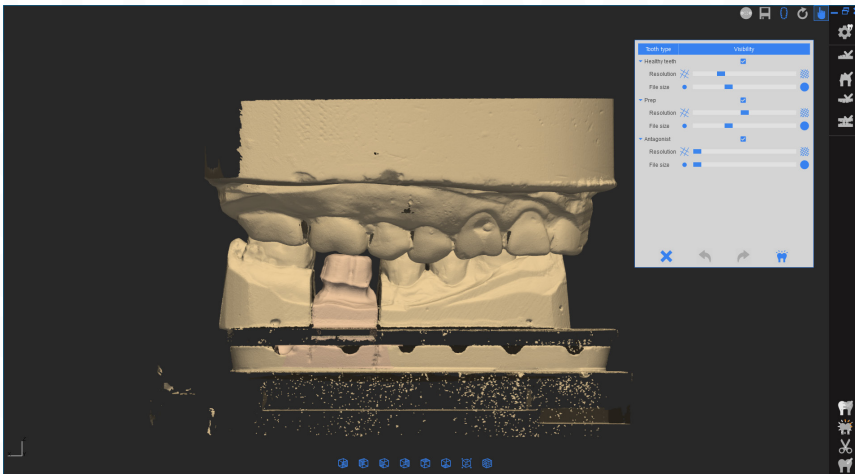

You can edit the last data before the final data confirmation. It can be helpful to reduce the merging time.

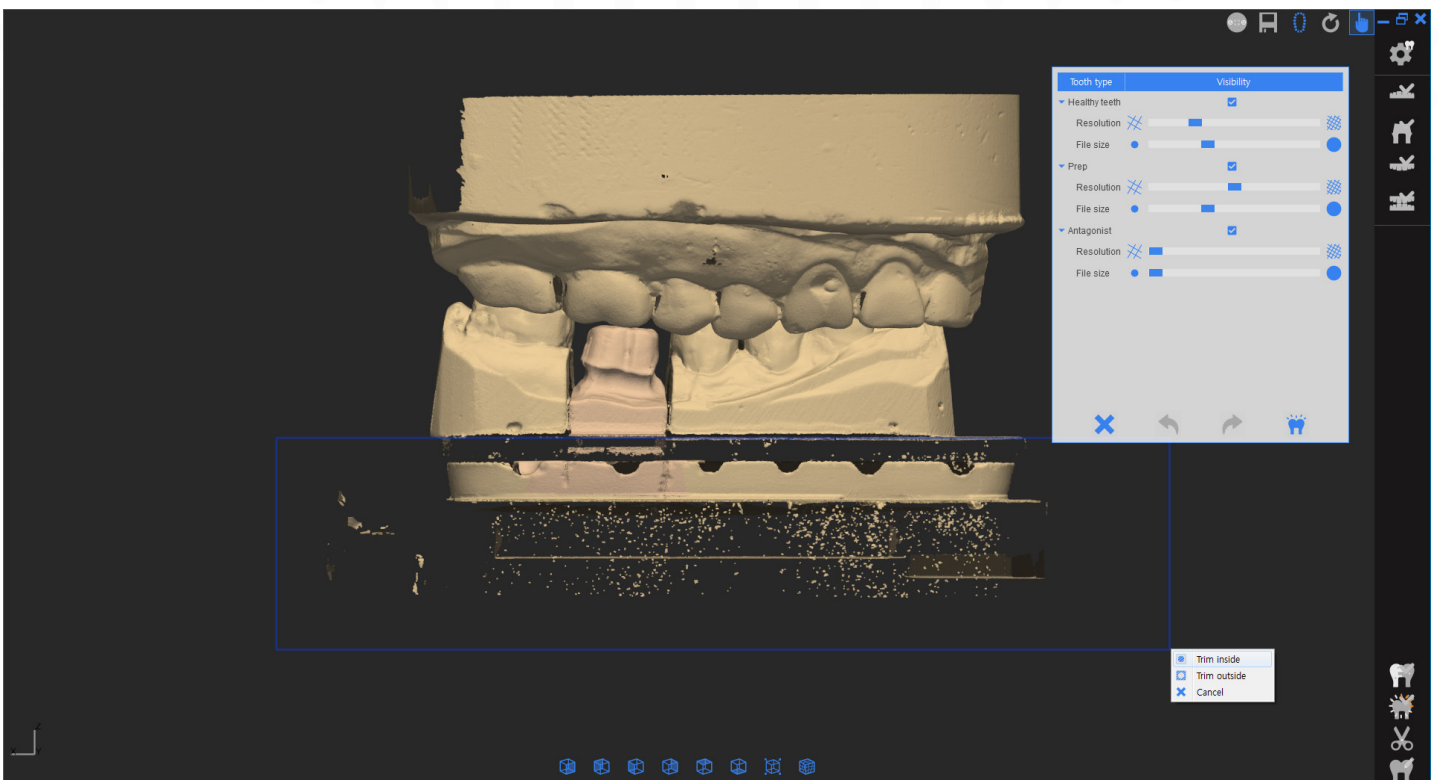

- 1 Click left mouse button and select unnecessary part for optimum data process. Then click "Trim Inside". 

You can also remove outside of rectangle area by clicking "Trim Outside". 



- 2 You can adjust file size and resolution of scanned data.
Click to get the final data.

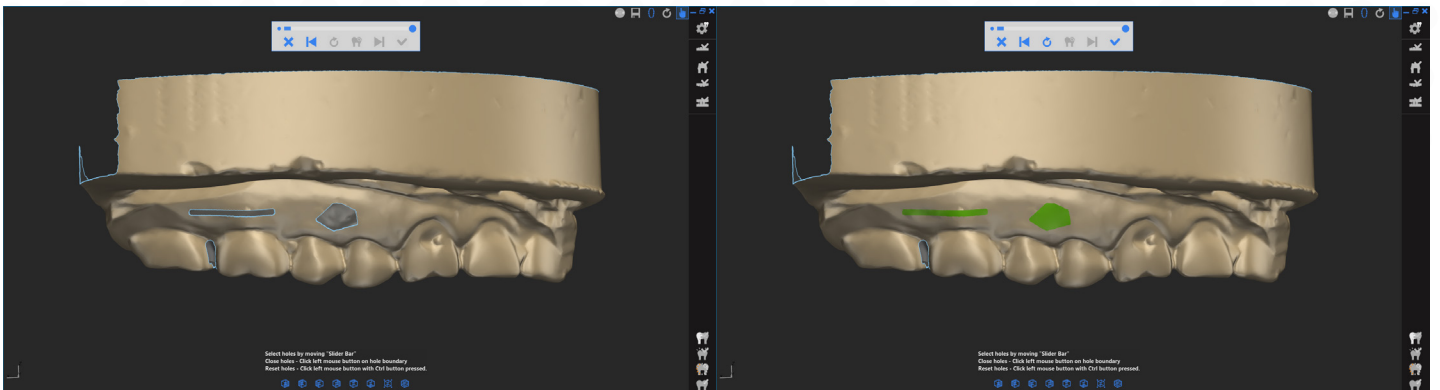

- 3 Fill out the holes by clicking

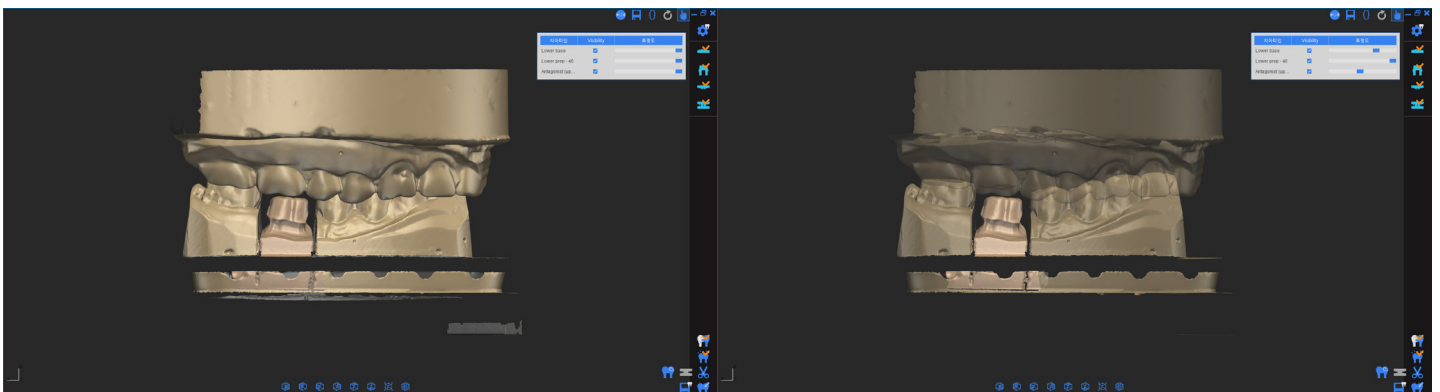

Even after you get the final data, you may edit the data by clicking

- 4 After you confirm the final data, click to save the data and proceed to the CAD design program by clicking

Our Office Locations

- **DOF Korea Headquarters**

info@doflab.com

+82 70-5057-5861

601-602, 77, Seongsuil-ro, Seongdong-gu, Seoul, 04790 Korea

서울특별시 성동구 성수일로 77 서울숲 IT 밸리 6층 601~602

- **DOF Europe GmbH**

info@doflab.com

+49 6196-7765675

Gustav-Stresemann-Ring 12-16, 65189, Wiesbaden, Germany

- **DOF Canada Office**

info@doflab.com

+1 647-880-7300

#6-527 Edgeley Blvd. Concord, ON Canada L4K 4G6

- **DOF China Office**

info@doflab.cn

+86 755-2331-9063

#2106, Xinghe Town Square, No.69 Jianshe Road, Machong Town, Dongguan, Guangdong, 523133, China

中国广东省东莞市麻涌镇星河城市广场2106室

- **DOF Japan Office**

teto@doflab.com

+81 (0)75-741-6542

#504 StalkBuildingSanjoKarasuma, Kamanzacho22Banchi, Nakagyo-ku Kyoto-shi, Kyoto, 604-8241, Japan

京都市中京区釜座町22番地 ストークビル三条烏丸504号室